



Instructions for installation and use

DE – ACHTUNG: Die Verwendung des INNOTECH-Produkts ist erst zulässig, nachdem die Gebrauchsanleitung in der jeweiligen Landessprache vollständig gelesen und verstanden wurde.

EN – ATTENTION: Use of the INNOTECH product is only permitted after the instruction manual has been read and fully understood in the respective language.

IT – ATTENZIONE: L'utilizzo del prodotto INNOTECH è permesso solo previa lettura e comprensione dell'intero manuale di istruzioni nella lingua del relativo paese di utilizzo.

FR – ATTENTION : L'utilisation du produit INNOTECH n'est autorisée qu'après avoir entièrement lu et compris la notice d'utilisation dans la langue du pays concerné.

NL – ATTENTIE: Dit INNOTECH-product mag pas gebruikt worden nadat u de gebruikershandleiding in de taal van het betreffende land gelezen en begrepen hebt.

ES – ATENCIÓN: Se autorizará el uso de los productos INNOTECH una vez que se hayan leído y entendido las instrucciones de uso en el idioma del país.

PT – ATENÇÃO: O uso do produto INNOTECH apenas é permitido depois de ter lido e compreendido na totalidade as instruções de uso na respetiva língua nacional.

DK – GIV AGT: Du må først bruge et produkt fra INNOTECH, efter du har læst og forstået brugsvejledningen i fuldt omfang i dit lands sprog.

SV – O B S : Denna INNOTECH-produkt får inte användas förrän bruksanvisningen på respektive lands språk har lästs igenom och förstås.

CZ – POZOR: Práce s výrobkem INNOTECH je povolena teprve po kompletním přečtení a porozumění návodu k použití v jazyku daného státu.

PL – UWAGA: Produkty firmy INNOTECH mogą być używane dopiero po dokładnym zapoznaniu się z całą instrukcją obsługi w odczytanym języku.

SL – POZOR: Uporaba izdelka INNOTECH je dovoljena šele po tem, ko ste navodila prebrali v celoti v ustreznem jeziku svoje dežele in jih tudi razumeli.

SK – POZOR: Produkt INNOTECH môžete používať až po prečítaní a porozumení celého návodu na použitie pre príslušnú krajinu.

HU – FIGYELEM: Az INNOTECH termékek használatá csak azt követően engedélyezett, hogy saját nyelven elolvasta és megértette a teljes használati utasítást.

TR – DİKKAT: INNOTECH ürününün kullanımına ancak ilgili ülkenin dilinde sunulmuş olan kullanım kılavuzunun tamamen okunmasından ve anlaşılmasından sonra izin verilir.

ZH – 注意: 只有在仔细阅读并完全理解了当地语言的使用说明后, 才能使用 INNOTECH 公司的产品。

[2]	DESCRIPTION OF SYMBOLS	3
[3]	SAFETY INSTRUCTIONS	4
[4]	COMPONENTS/MATERIAL	6
[5]	PRODUCT APPLICATION/APPROVAL	7
[6]	INSPECTION	9
[7]	WARRANTY	10
[8]	SIGNS & MARKINGS	10
[9]	DIMENSION	11
[10]	INSTALLATION INSTRUCTIONS	12
[11]	INSTALLATION SUBSTRUCTURE	12
[12]	INSTALLATION TOOLS	13
[13]	INSTALLATION	13
[14]	SAMPLE APPLICATIONS	16
[15]	STRESS DIRECTIONS	17
[16]	DISPOSAL	17
[17]	ACCEPTANCE REPORT	18
[18]	FALL PREVENTION SYSTEM NOTICE	20
[19]	INSPECTION REPORT	21
[20]	DEVELOPMENT & SALES	23

Warnings / Danger notices

For an IMMEDIATE danger, which could lead to severe injury or death.



For a POTENTIALLY dangerous situation, which could lead to severe injury or death.



For a POTENTIALLY dangerous situation, which could lead to injuries and property damage.



Wear protective gloves!



Wear protective glasses!

**Additional information/notice**

correct



incorrect



Follow the manufacturer's instructions/the respective user manuals.

The following safety instructions and the latest technological standards must be taken into account.

3.1 GENERAL

- The safety system may only be assembled according to the latest technological standards and by an appropriately trained, competent professional who is familiar with the safety system.
- The protective equipment may only be used by persons who:
 - are trained in the use of "Personal Protective Equipment" (PPE).
 - are physically and psychologically fit. Health restrictions such as heart/circulatory problems, medication, alcohol consumption, etc. compromise the user's safety.
 - are familiar with the locally applicable safety regulations.
- All applicable accident prevention rules (e.g. those for work on roofs) must be followed during installation and use of the safety system.
- The possible uses, restrictions and risks of using the protective equipment must be understood and accepted.
- An emergency plan must be available which includes rescue measures for all possible emergencies.
- Before works begin, measures must be taken to ensure that no objects can fall down from the workspace. The area under the workspace (sidewalk, etc.) must be kept clear.
- The anchor point should be planned, installed and used in such a way that proper use of the personal protective equipment (PPE) makes a fall over the edge impossible. (See planning documents at www.innotech.at).
- The positions of the anchor points are to be visibly documented (e.g. with a sketch of the rooftop) at the access point to the roof safety system.
- If, after acceptance of the safety system, renovation work is undertaken near it, it must be established that this renovation has no impact on the safety of the installed safety system! In case of doubt, a structural engineer or the manufacturer must be consulted.
- After being subjected to the stress of a fall, the entire safety system is to be taken out of operation and inspected by a competent professional (component parts, fastenings to the substructure, etc.)
- The safety system must not be altered in any way.
- On slanted roofs, the proper snow catching features must be added to prevent ice or snow from sliding from the roof surface.

- If access to the safety system is granted to an external contractor, their familiarity with this user manual is to be confirmed in writing.
- Should the equipment be sold to a customer abroad, the user manual is to be provided in the appropriate local language!
- The local lightning protection regulations are to be observed.

3.2 FOR FITTERS: FOR SAFE INSTALLATION

- All stainless steel screws are to be treated with a suitable lubricant before assembly (included: Weicon AntiSeize ASW 10000 or equivalent).
- Stainless steel may not come into contact with sanding dust or steel tools, as this can lead to corrosion.
- Proper fastening of the safety system must be documented with fastening reports and photos of the respective circumstances of installation.
- Installers must ensure that the substructure is appropriate for the fastening of the anchoring materials. In case of doubt, consult a structural engineer.
- The roof covering must be sealed according to the appropriate regulations.



Should any confusion arise during installation, it is the manufacturer must be contacted.

3.3 FOR USERS: FOR SAFE USE

- The minimum free space necessary under the edge is calculated as follows: Deformation of the anchor device in case of stress + manufacturer's specification of the personal protective equipment used, including deflection of the cable + body height + 1 m safety margin.
- Correct use of the individual elements, including the "personal protective equipment" must be insured, since the safe functioning of the fall protection system is otherwise NOT guaranteed.
- Attachment to the fall protection system is always completed through the rotating anchorage eye with a carabiner and must be used with personal protective equipment in accordance with EN 361 (safety harness) and EN 363 (fall arrest system).
- **ATTENTION!** For horizontal use, only lanyards which are designed for this application and have been tested for the respective edge type (sharp edges, trapezoidal sheets, steel girders, concrete, etc.) can be used.
- Do NOT use fall arrest systems if wind speeds exceed normal parameters.
- The fall protection system must NOT be used by children or pregnant women.

4.1 INNOTECH "EAP-INDUSTRY-31"

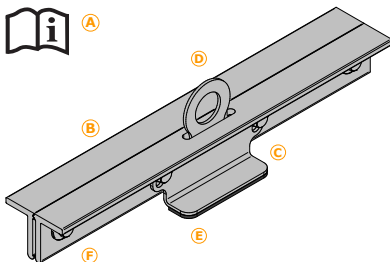

- A) **Instruction manual**
- B) **Clamping strip:** aluminium 6060
- C) **Support strip:** stainless steel AISI 304
- D) **Single anchor point:** stainless steel AISI 304
- E) **Rubber base:** EPDM
- F) **Fastening screws / nuts:** stainless steel AISI 304

4.2 INNOTECH "SZH-INDUSTRY-31"

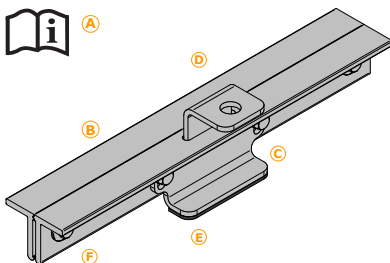

- A) **Instruction manual**
- B) **Clamping strip:** Aluminium 6060
- C) **Support strip:** stainless steel AISI 304
- D) **Insertion sheet for intermediate bracket:** stainless steel AISI 304
- E) **Rubber base:** EPDM
- F) **Fastening screws / nuts:** stainless steel AISI 304

5.1 INNOTECH "EAP-INDUSTRY-31"

INNOTECH „EAP-INDUSTRY-31“ was developed

- as an **anchor point** for flat or slanted roofs for the personal safety of **2 persons** (including 1 person for first aid administration), and is suitable for the following fall prevention systems in accordance with EN 363:2008:
 - Restraint systems
 - Workplace positioning systems
 - Fall arrest systems
 - Rescue systems

**DANGER OF DEATH if used incorrectly.**

- Use INNOTECH fall prevention systems **ONLY** for personal safety.
- **NEVER** hang loads on INNOTECH fall prevention systems which have not been approved in this instruction manual.



Follow the manufacturer specifications of the personal protective equipment used.

INNOTECH „EAP-INDUSTRY-31“ has been tested in accordance with **EN 795:2012 TYP A & CEN/TS 16415:2013.**

The authority notified for the type test:

DEKRA EXAM GmbH, Dinnendahlstraße 9, D-44809 Bochum

5.2 INNOTECH "SZH-INDUSTRY-31"

INNOTECH „SZH-INDUSTRY-31“ was developed

- as an anchor point on a flat or slanted roof for personal safety and as an intermediate bracket in the INNOTECH horizontal lifeline system (not included!) in accordance with EN 795:2012 TYP C & CEN/TS 16415:2013.

**DANGER OF DEATH if used incorrectly.**

- Use INNOTECH fall prevention systems ONLY for personal safety.
- NEVER hang loads on INNOTECH fall prevention systems which have not been approved in this instruction manual.

**Follow the manufacturer specifications of the personal protective equipment used.**

INNOTECH „SZH-INDUSTRY-31“ has been tested in accordance with **EN 795:2012 TYP C**.

The authority notified for the **type test**:

DEKRA EXAM GmbH, Dinnendahlstraße 9, D-44809 Bochum

6.1 INSPECT BEFORE EACH USE

INNOTECH fall prevention systems must be checked visually before each use for any obvious defects.

**DANGER OF DEATH if INNOTECH standard posts are damaged.**

- The INNOTECH fall prevention system must be in faultless condition.
- Do NOT use the INNOTECH fall prevention system if:
 - damage or wear on the components are visible,
 - any other defects have been observed (loose screw connections, deformations, corrosion, wear, etc.),
 - strain has occurred due to a fall (exception: first aid administration),
 - the product designation is illegible.

Check the entire fall protection system's suitability for use with the help of the acceptance and inspection reports.



**If there are any doubts concerning the reliable operation of the fall protection system, it must NOT be used until being checked by a qualified professional (with written documentation).
If necessary, replace the product.**

6.2 ANNUAL INSPECTIONS

INNOTECH fall prevention systems must be inspected at least once annually by a qualified professional who is familiar with the system. The safety of the user depends on the effectiveness and durability of the equipment.

Shorter inspection intervals may be necessary, depending on the intensity and environment of use (e.g. in a corrosive atmosphere, etc.).

Document the inspection by the qualified professional in the inspection report included in the instruction manual and keep it on record with the manual.



Inspection intervals are found in the inspection report.

7

WARRANTY

The warranty period for manufacturing defects on all components (under normal conditions of use) is 2 years from the date of purchase. The term is shortened if they are used in corrosive atmospheres.

If there is a strain (fall, weight of snow, etc.) the warranty claim is void for those components that have been designed to absorb energy or that may have been deformed.



For system installation and for components planned and installed under the responsibility of specialised professional installation companies, INNOTECH neither assumes responsibility nor is it bound by warranty in the case of improper installation.

8

SIGNS & MARKINGS

8.1 INNOTECH "EAP-INDUSTRY-31"

A) Name or logo of the manufacturer/seller:

B) Type designation:

C) Sign that the instruction manual must be followed:

D) Maximum number of people who can be secured:

E) Year of manufacture and manufacturer's serial number:

F) Number of the applicable norm:

INNOTECH

EAP-INDUSTRY-31



2 (including 1 person for first aid administration)

JJJJ-...-...

EN 795:2012 TYP A &
CEN/TS 16415:2013

A

INNOTECH

C



EAP-INDUSTRY-31

B

E

JJJJ-...-...

special designed for

Stehfalz / standing seam / lamiera aggraffata /
joint debout / staande naad / junta alzada



max.



01-06-31-AurKleber-A

F

EN 795:2012 TYP A +
CEN/TS 16415:2013

8

SIGNS & MARKINGS

8.2 INNOTECH "SZH-INDUSTRY-31"

- A) Name or logo of the manufacturer/seller:
 B) Type designation:
 C) Sign that the instruction manual must be followed:
 D) Year of manufacture and manufacturer's serial number:
 E) Number of the applicable norm:

INNOTECH
 SZH-INDUSTRY-31



JJJJ-... ..

EN 795:2012 TYP C



Stehfalz / standing seam / lamiera aggraffata /
 joint debout / staande naad / junta alzada



E EN 795:2012 TYP C

02-15-31-Aufkleber-A

9

DIMENSIONS

9.1 INNOTECH "EAP-INDUSTRY-31"

[mm]

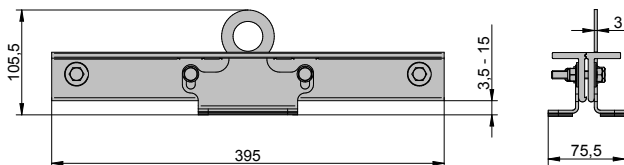

9.2 INNOTECH "SZH-INDUSTRY-31"

[mm]

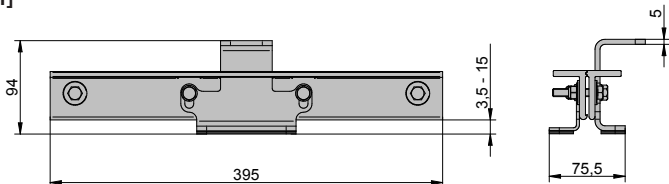

10

INSTALLATION INSTRUCTIONS

EN

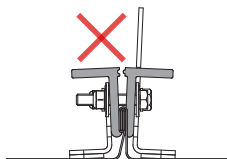
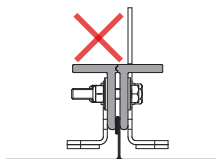
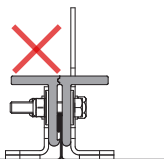
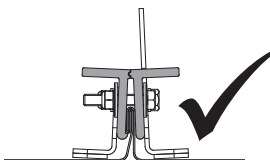
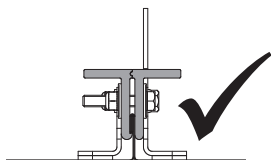

11

INSTALLATION SUBSTRUCTURE

The prerequisite for a proper and professional installation is a double standing seam roof which has been installed according to the applicable norms / standards (sheet thickness: **steel $\geq 0.5\text{mm}$; aluminium $\geq 0.7\text{mm}$; titanium zinc $\geq 0.7\text{mm}$; copper $\geq 0.6\text{mm}$**) and a static load-bearing subconstruction.



OPTIONAL: "EAP-INDUSTRY-31 / SZH-INDUSTRY-31"
for copper roofs on inquiry



DANGER OF DEATH if installed on an unsuitable substructure.

- Ensure to ensure that a static load-bearing subconstruction is present. In case of doubt, have the installation substructure inspected by a structural engineer or the manufacturer.

12 INSTALLATION TOOLS

[mm]

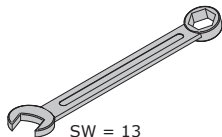

SW = 13

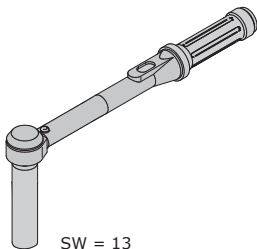

SW = 13

13 INSTALLATION



DANGER

DANGER OF DEATH if NOT installed correctly.

- INNOTECH fall prevention systems must be installed properly and according to the instruction manual.
- A spacing of min. 1500 mm must be maintained from the edge of the roof (see illustration).

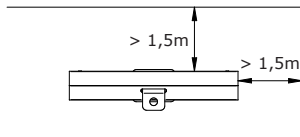
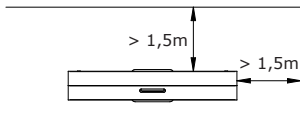

CAUTION



INJURY can result from sharp edges of structural components.

- Wear protective gloves during installation work.

13 INSTALLATION

13.1 POSITIONING ON THE ROOF

1.

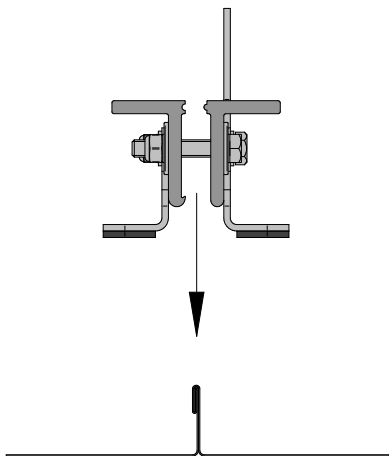

2.

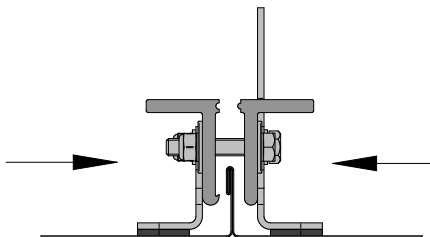

13 INSTALLATION

3.

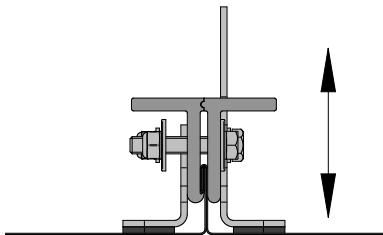

13.2 FASTENING THE CLAMPS ON THE ROOF

1.



SW = 13



SW = 13

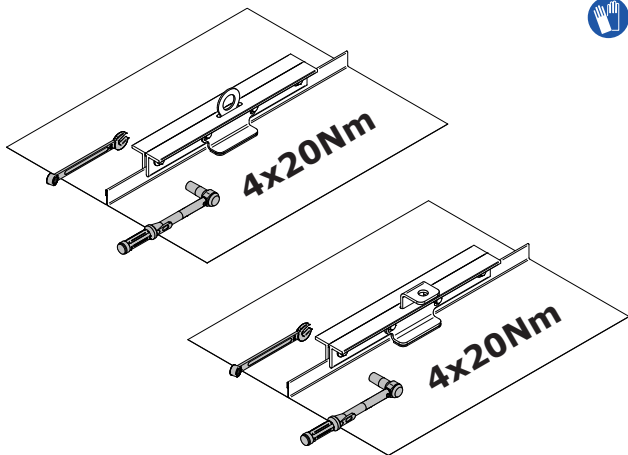

Observe torque indication!

13 INSTALLATION

2.

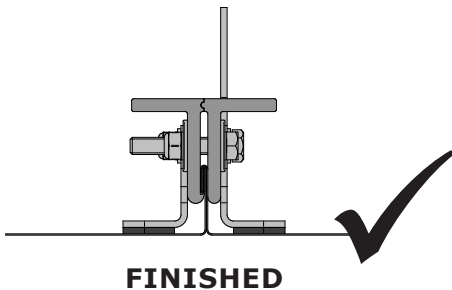

14 SAMPLE APPLICATIONS

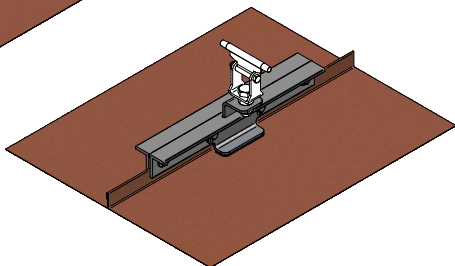
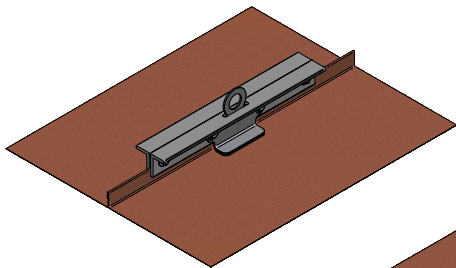

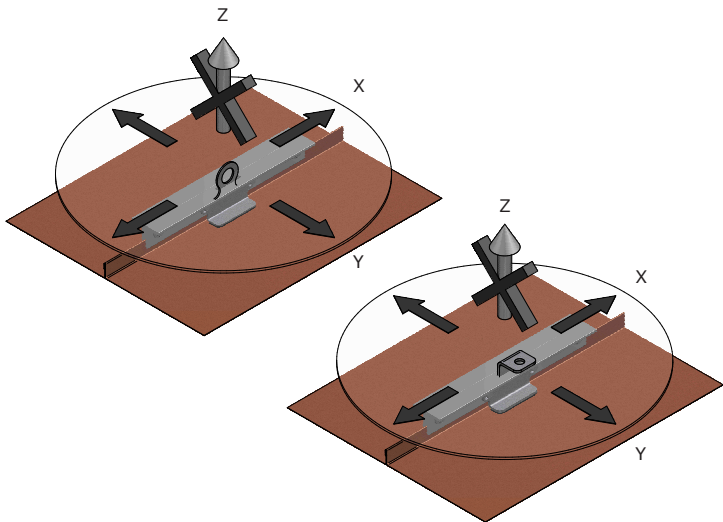

DANGER OF DEATH if used in NON-APPROVED stress directions.

- INNOTECH fall prevention systems may only be used in the approved stress directions.
- Work / use loads along the "z-axis" are NOT permitted.

Do NOT dispose of the fall protection system in the house waste.
Following national requirements, gather the used parts and dispose of them in an environmentally responsible fashion.

ACCEPTANCE REPORT NR. _____ (PART 1/2)

E A P / S Z H - I N D U S T R Y - 3 1

CONTRACT NR:

PROJECT:

CUSTOMER:

Specialist:

Company address:

CONTRACTOR:

Specialist:

Company address:

INSTALLATION: (check applicable box!) **EAP** (Single anchor points) **ANCHOR POINTS** of a horizontal lifeline system as per EN 795:2012 TYP CSpecialist:

Company address:

ACCEPTANCE REPORT NR. _____ (PART 2/2)

E A P / S Z H - I N D U S T R Y - 3 1

FASTENING DOCUMENTATION / PHOTO-DOCUMENTATION

PRODUCT: Pcs. _____ (Type designation EAP/fastening point/SDH)

Year of manufacture/Serial number: _____

Installation substructure: _____

(e.g.: sheet roofs: roof manufacturer, profile, material, sheet thickness; etc.)

Date:	Location: (e.g.: Hall 7)	Tightening torque:	Photos: (Save directory)
		Nm	
		Nm	

The undersigned installation company ensures the correctness of their work (edge spacing, inspection of the substructure, proper cleaning of drill holes, observation of hardening times, working temperature and screw manufacturer guidelines, etc.). The customer accepts the services of the contractor. The instruction manuals, fastening documentations/ photo-documentations, and inspection reports were given to the customer (building owner) and are to be made available to the user. At the point of access to the fall prevention system, the positions of the anchor points are to be documented by the building owner by means of plans (e.g. sketches of the rooftop).

The contractor, a qualified professional who is familiar with the fall prevention system, confirms that the installation was performed correctly, up to the latest technological standards and according to the manufacturer's instruction manual. The reliability and safety is confirmed by the contracting company.

Delivery of: (e.g. personal protective equipment PPE, fall arrest devices HSG, storage cabinet, etc.)

Pcs. _____ Pcs. _____ Pcs. _____ Pcs. _____

Incorporated in the existing lightning protection system? YES NO

Comments: _____

Name: _____

Customer

Contractor (Qualified professional familiar with the fall prevention system)

Date, company seal, signature

Date, company seal, signature

INFORMATION ON THE FALL PREVENTION SYSTEM

The building owner is to make this notice visible at the system access point!

Use of the system must be up to technological standards and the instruction manuals.

Instruction manuals and other documentation is kept in:

- Overview of the area with the position of anchor point:

Areas where falling through could occur (e.g. skylights and/or strip lights) must be marked!

The maximum load capacities of the anchor points are stated in the respective instruction manuals or the type plate of the fall prevention system!

If subjected to the stress of a fall or in case of doubt, the anchor point is to be removed from use immediately and sent to the manufacturer or a qualified repair facility for inspection and repair.

This also applies to damages to the fastening components.

INSPECTION REPORT NR. _____ (PART 1/2)

E A P / S Z H - I N D U S T R Y - 3 1

CONTRACT NR: _____

PROJECT: _____**PRODUCT:** Pcs. _____ (Type designation EAP/fastening point/SDH)

Year of manufacture/Serial number: _____

ANNUAL SYSTEM INSPECTION CONDUCTED ON: _____

NEXT ANNUAL SYSTEM INSPECTION TO BE CONDUCTED BY: _____

CUSTOMER: Specialist: 

Company address: _____

CONTRACTOR: Specialist: 

Company address: _____

INSPECTION POINTS:	OBSERVED DEFECTS:
<input checked="" type="checkbox"/> checked and in order!	(Description of defect/measures to be taken)
DOCUMENTATION:	
<input type="checkbox"/> Instruction manuals	
<input type="checkbox"/> Acceptance reports/fastening documentation/ pohtodocumentation	
PPE (Personal Protective Equipment for fall protection): Inspection according to manufacturer's instructions	
<input type="checkbox"/> Date of expiry	
<input type="checkbox"/> routine annual inspection conducted	
<input type="checkbox"/> not inspected (no authorisation)	
ROOF COVERING:	
<input type="checkbox"/> no damages	
<input type="checkbox"/> no corrosion	
<input type="checkbox"/>	

INSPECTION REPORT NR. _____ (PART 2/2)

E A P / S Z H - I N D U S T R Y - 3 1

INSPECTION POINTS: checked and in order**OBSERVED DEFECTS:**

(Description of defect/measures to be taken)

VISIBLE PARTS OF THE ANCHOR POINT: no deformation no corrosion firmly positioned screw fastenings secure tightening torque of screw fastenings**ROOF COVERING:** no damages no corrosion**HORIZONTAL LIFELINE SYSTEM:****Attention:**

For horizontal lifeline systems, the inspection report of the ALLinONE-TYP instruction manual (see instruction manual for template) must be completed!

Result of acceptance: The fall prevention system matches the manufacturer's instruction manual and the latest technological standards. Its safety and reliability is hereby confirmed.

Comments: _____

Name: _____
 Costumer

 Contractor (Qualified professional familiar with the fall prevention system)

 Date, company seal, signature

 Date, company seal, signature

INNOTECH Arbeitsschutz GmbH, Laizing 10, A-4656 Kirchham/Austria
www.innotech.at

