

# LIFELINE-KIT

## Instruction manual



**DE – ACHTUNG:** Die Verwendung des INNOTECH-Produkts ist erst zulässig, nachdem die Gebrauchsanleitung in der jeweiligen Landessprache vollständig gelesen und verstanden wurde.

**EN – ATTENTION:** Use of the INNOTECH product is only permitted after the instruction manual has been read and fully understood in the respective language.

**IT – ATTENZIONE:** L'utilizzo del prodotto INNOTECH è permesso solo previa lettura e comprensione dell'intero manuale di istruzioni nella lingua del relativo paese di utilizzo.

**FR – ATTENTION :** L'utilisation du produit INNOTECH n'est autorisée qu'après avoir entièrement lu et compris la notice d'utilisation dans la langue du pays concerné.

**NL – ATTENTIE:** Dit INNOTECH-product mag pas gebruikt worden nadat u de gebruikershandleiding in de taal van het betreffende land gelezen en begrepen hebt.

**ES – ATENCIÓN:** Se autorizará el uso de los productos INNOTECH una vez que se hayan leído y entendido las instrucciones de uso en el idioma del país.

**PT – ATENÇÃO:** O uso do produto INNOTECH apenas é permitido depois de ter lido e compreendido a totalidade as instruções de uso na respetiva língua nacional.

**DK – GIV AGT:** Du må først bruge et produkt fra Innotech, efter du har læst og forstået brugsvejledningen i fuldt omfang i dit lands sprog.

**SV – O B S :** Denna INNOTECH-produkt får inte användas förrän bruksanvisningen på respektive lands språk har lästs igenom och förstås.

**CZ – POZOR:** Práce s výrobkem INNOTECH je povolena teprve po kompletním přečtení a porozumění návodu k použití v jazyku daného státu.

**PL – UWAGA:** Produkty firmy INNOTECH mogą być używane dopiero po dokładnym zapoznaniu się z całą instrukcją obsługi w ojczystym języku.

**SL – POZOR:** Uporaba izdelka INNOTECH je dovoljena šele po tem, ko ste navodila prebrali v celoti v ustreznem jeziku svoje dežele in jih tudi razumeli.

**SK – POZOR:** Produkt INNOTECH môžete používať až po prečítaní a porozumení celého návodu na použitie pre príslušnú krajinu.

**HU – FIGYELEM:** Az INNOTECH termékek használatra csak azt követően engedélyezett, hogy saját nyelvén elolvasta és megértette a teljes használati utasítást.

**TR – DİKKAT:** INNOTECH ürününün kullanımına ancak ilgili ülkenin dilinde sunulmuş olan kullanım kılavuzunun tamamen okunmasından ve anlaşıldığından sonra izin verilir.

**ZH – 注意 :** 只有在仔细阅读并完全理解了当地语言的使用说明后, 才能使用 INNOTECH 公司的产品。

[2]	DESCRIPTION OF SYMBOLS	3
[3]	SAFETY INSTRUCTIONS	4
[4]	COMPONENTS/MATERIAL	6
[5]	USE	8
[6]	INSPECTION	9
[7]	WARRANTY	10
[8]	APPROVAL	11
[9]	SIGNS & MARKINGS	11
[10]	DIMENSIONS	12
[11]	INSTALLATION INSTRUCTIONS	12
[12]	INSTALLATION SUBSTRUCTURE	13
[13]	INSTALLATION TOOLS	13
[14]	INSTALLATION	14
[15]	FALL HEIGHT	22
[16]	WASTE DISPOSAL	23
[17]	ACCEPTANCE LOG	24
[18]	FALL PROTECTION SYSTEM INSTRUCTIONS	26
[19]	TEST LOG	27
[20]	DEVELOPMENT & SALES	29
[21]	SYSTEM VARIANTS	30
[22]	ATTACHMENT	32

**Warning/danger information**

For an IMMEDIATE threat of danger that can cause serious physical injuries or death.



For a POTENTIALLY dangerous situation that can cause serious physical injuries or death.



For a POTENTIALLY dangerous situation that could lead to minor physical injuries and damage to property



Wear gloves!



Wear safety spectacles!

**Supplementary information/instructions**

**correct**



**incorrect**



Comply with manufacturer information/instruction manual.

The following safety instructions and the current state of the art must be taken into consideration.

## 3.1 GENERAL INFORMATION

- The fall protection system may be installed and used only by persons who:
  - are trained in "personal protective equipment" (PPE).
  - are in good physical and mental health. Medical conditions such as cardiovascular problems, intake of medicines, consumption of alcohol, etc. negatively affect the safety of the user.
  - are familiar with the locally applicable safety regulations.
- The safety system should be installed only by specialised/experts familiar with the roof safety system, and in compliance with the current state of the art.
- Adhere to the respective accident prevention regulations (e.g. working on roofs) when installing/using the INNOTECH "LIFELINE-KIT" fall protection system.
- A plan must be available that specifies rescue procedures for all possible emergencies.
- Measure the fall space so that if the user falls, he does not hit an obstacle, and that an impact with the ground is NOT possible.
- You should plan, install and use the anchorage point in such a way that none can fall over the edge if the personal protective equipment is used properly. (See planning documents on [www.wwww.innotech.at](http://www.wwww.innotech.at))
- Safety harnesses and the length of the lanyard must be matched to the respective structure, and must satisfy the applicable standards.
- In order to prevent a fall, people who are active in areas where there is danger of falling must ensure that the connection to the fall protection system is kept as short as possible.
- Every fall protection system is subject to maximum limit values. The limit values are specified on the rating plate of the fall protection system, and must NOT be exceeded.
- If the system has been installed without penetrating the roof, then after strong storms, inspect the sheet metal roof (installation substructure) before continuing to use the fall protection system.
- If used on sloping roofs, roof avalanches (ice, snow) must be avoided by means of suitable devices to intercept snow.
- When using together with EN 795 TYPE C + E products, comply with the applicable product descriptions.
- Do not make any changes to the fall protection system.
- The cable system must be protected against lightning in accordance with the lightning protection regulations applicable in the respective country. It should not be used as a lightning conductor.

- If you provide the fall protection system to external contractors, their familiarity with this instruction manual must be confirmed in writing.
- If the fall protection system is sold in other countries, the instruction manual must be provided in the respective national language.

### 3.2 FOR SAFE ASSEMBLY

- Before installation, lubricate all stainless steel bolts with a suitable lubricant (included: Weicon AntiSeize ASW 10000 or equivalent quality).
- Ensure that stainless steel does not come into any contact with swarf or steel tools, as this may lead to corrosion.
- Install the restraint system in such a way that it is impossible for contact to occur with sharp edges or other objects because of deflection during a fall arrest event. Otherwise, injuries may arise!
- The professional attachment of the fall protection system to the building must be documented with dowel logs and photos.
- The roof covering must be properly sealed in accordance with applicable guidelines.



If uncertainties arise during installation, it is imperative that you contact the manufacturer ([www.innotech.at](http://www.innotech.at)).

### 3.3 FOR SAFE USE

- The minimum free space necessary under the edge is calculated as follows: Deformation of the anchorage device in the event of strain + Manufacturer's specification of the personal protective equipment used including deflection of the cable + body height + 1 m safety margin.
- Correct use of the individual elements including personal protective equipment must be ensured, because otherwise the safe functioning of the INNOTECH "LIFELINE-KIT" is NOT guaranteed.
- For horizontal use, only fasteners may be used that are suitable for this purpose and have been tested for the respective edges (sharp edges, trapezoidal corrugated sheeting, steel girders, concrete, etc.).
- Do NOT use the fall protection system if wind speeds exceed normal parameters.
- When dealing with special weather conditions (salt spreading in the winter (bridges), sulphurous air, etc.), the fall protection system components must be of "quality SS316" manufacture.
- The fall protection system must NOT be used by children and pregnant women.

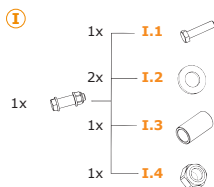
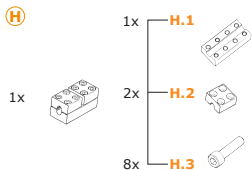
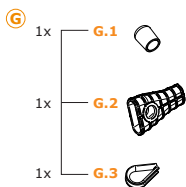
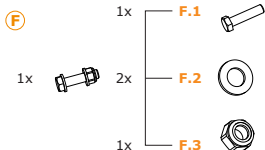
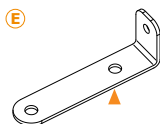
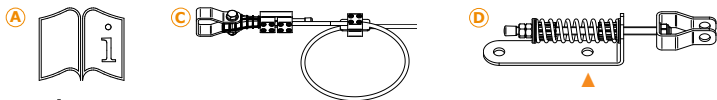

## OPTIONAL:

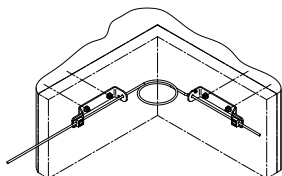
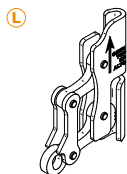
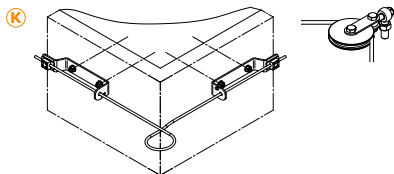
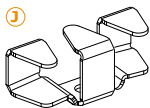

- A) Instruction manual**
- B) Lubricant:** Weicon AntiSeize ASW 10000
- C) End lock with shock absorber** (cable loop - pre-fitted):  
Stainless steel, quality SS304; aluminium; stainless steel cable  $\varnothing$  8 mm - 7 x 7 -  
breaking load 37 kN
- D) End attachment with spring pre-tension** (pre-fitted): Stainless steel, quality SS304
- E) End attachment for end lock (C):** Stainless steel, quality SS304
- F) Kit for connecting the end lock (C)  
to the end attachment (E):** Stainless steel, quality SS304
- F.1) Hexagonal bolt M12**
- F.2) Washer M12**
- F.3) Locknut M12**
- G - I) Kit (end lock):** for attaching the cable end to the end attachment (D)
- G) Kit:**
- G.1) Closing cap:** PVC
- G.2) Thimble retractor:** PP
- G.3) Thimble:** Stainless steel, quality SS316
- H) Kit:**
- H.1) Indicator clamp below, 2x:** Aluminium
- H.2) Indicator clamp above:** Aluminium
- H.3) Cylinder bolts M6:** Stainless steel, quality SS304
- I) Kit:** Stainless steel, quality SS304
- I.1) Hexagonal bolt M12**
- I.2) Washer M12**
- I.3) Holding sleeve  $\varnothing$  16 mm**
- I.4) Locknut M12**
- OPTIONAL:**
- J) Intermediate brackets (INNOTECH "KIT-SZH-10"):** Stainless steel, quality SS304  
for a cable span greater than 15 m,  
installation on façades or support structures,  
pass-over capability without moving or removing the system
- K) Corner elements (INNOTECH "KIT-EDLE-10", INNOTECH "AIO-EDLE-14"):**  
suitable for interior and exterior corners as well as ceiling installation
- L) INNOTECH "VERT-GLEIT":** Stainless steel, quality SS304

INNOTECH "LIFELINE-KIT" was developed as an **anchorage device** for personal protection for **4 people** (including 1 person for first aid use), and is suitable for the following fall protection systems in accordance with EN 363:2008:

- Fall protection systems
- Fall arrest systems
- Rescue systems



For fall protection systems, if you are using the cable span with a fall arrester, then the lanyard must be adjusted so that a fall is impossible.



**DANGER TO LIFE from incorrect use.**

- INNOTECH "LIFELINE-KIT" must be used **ONLY** for personal safety.
- Do **NOT** use INNOTECH "LIFELINE-KIT" for abseiling work.
- Use **ONLY** self retracting lanyards which are approved for horizontal lifeline systems.
- **NEVER** hang loads on the INNOTECH "LIFELINE-KIT" which are **NOT** expressly approved in this instruction manual.



**Comply with the manufacturer information for the personal protective equipment used.**

To keep the fall strain low for personnel, the lifeline is equipped with modern pre-tensioning and shock-absorbing elements.

**Through the combination of spring pre-tension and shock absorbers, the forces at the end and corner points reduce to max. 10 kN in the case of a fall.**

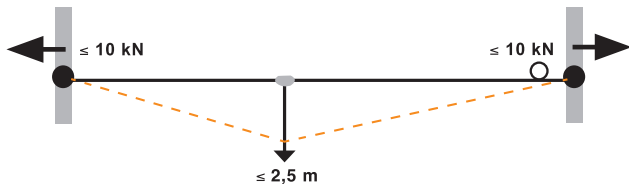

**The lifeline system feeds a maximum force of 10 kN into the end, corner, and intermediate anchorage points.**



# 5

## INTENDED USE

INNOTECH "LIFELINE-KIT" consists of non-rusting 8 mm stainless steel cable. The stainless steel cable is supported by two end attachments.

**OPTIONAL:** INNOTECH "LIFELINE-KIT" with corner elements and intermediate pass-over brackets.



### **DANGER TO LIFE from incorrect use.**

- Use carabiners which comply with EN 362 to attach to the INNOTECH "LIFELINE-KIT".
- If the cable system is mounted at a cant greater than 15°, use is permitted ONLY with INNOTECH "VERT-GLEIT" as per EN 353-1/795 C. Intermediate brackets and corner elements must not be traversed in the engaged status using the INNOTECH "VERT-GLEIT".

# 6

## INSPECTION

### 6.1 TO BE CHECKED BEFORE EACH USE

Prior to each use, INNOTECH "LIFELINE-KIT" must be checked visually for any obvious defects.



### **DANGER TO LIFE through damage/defects on the INNOTECH "LIFELINE-KIT".**

- INNOTECH "LIFELINE-KIT" must be in perfect working condition.
- Inspect cable loop(s) ( $\varnothing$  approx. 220 mm) and spring pre-tension in the end connections (cable pre-tension).
- Check the safety harness, lanyard, and anchorage points as specified in the applicable instruction manual.
- Do not use INNOTECH "LIFELINE-KIT" any longer, if:
  - Damage or wear to its components are obvious.
  - other defects were identified (loose connections, deformations, corrosion, wear, defective roof sealing).
  - strain has occurred due to a fall (Exception: First aid help).
  - it is not possible to read the product labelling.

Check the entire fall protection system's suitability for use by using the acceptance protocol and test protocol.



**If there is doubt about the safe functioning of the fall protection system, do NOT use it any more, and have it inspected by a specialist (written documentation).**

**If necessary, replace the product.**

# 6

## INSPECTION

### 6.2 ANNUAL CHECKS

Have INNOTECH "LIFELINE-KIT" inspected at least once a year by a specially trained technician who is familiar with the fall protection system. The user's safety depends on the effectiveness and durability of the equipment.

Shorter intervals between testing may be required depending on the intensity of use and the environment (e.g. in corrosive atmospheres, lightning strike, etc.).

Document the verification by the specialist/technician in the instruction manual test logs and keep them in the same place as the instruction manual.



**Document the inspection intervals in the test log.**

# 7

## WARRANTY

The warranty period for manufacturing defects on all components, under normal user conditions, is 2 years from the date of purchase. The time limit is shortened if it is used in corrosive atmospheres.



If there is strain (a fall, weight of snow, etc.,) the warranty claim is void for those components that have been designed to absorb energy, or that may possibly be deformed.



**For system installation and for components planned and installed under the responsibility by specialised installation companies, INNOTECH® assumes neither responsibility nor warranty in the case of improper installation.**

INNOTECH "LIFELINE-KIT" has been tested and certified in accordance with  
**EN 795:2012 TYPE C.**

The notified authority participating in the type test:  
DEKRA EXAM GmbH, Dinnendahlstrasse 9, D-44809 Bochum

- A) Name or logo of the manufacturer/retailer:** INNOTECH®  
**B) Type designation:** LIFELINE-KIT  
**C) Signs stating that instruction manual must be followed:**   
**D) Maximum number of people who can be attached:** 4 (including 1 person for first-aid administration)  
**E) DEKRA seal:**   
**F) Year of manufacture and manufacturer's serial number:** JJJJ-.-...  
**G) Number of the relevant standard:** EN 795:2012 TYPE C  
**H) Shock absorber:** YES  
**I) Max. cable deflection:** 2.5 m  
**J) Installed by:** Name & address of the installation company



# 10 DIMENSIONS

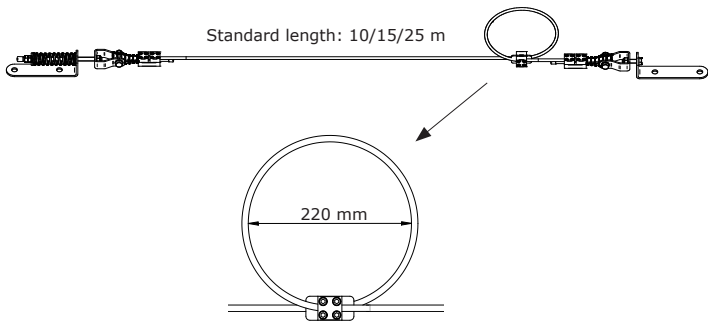

# 11 INSTALLATION INSTRUCTIONS

Attach INNOTECH "LIFELINE-KIT" to suitable anchorage points (e.g. INNOTECH "STABIL", etc.) which are aligned horizontally.

The end anchorage points, intermediate, and corner holders used to attach the INNOTECH "LIFELINE-KIT" must comply with the requirements specified in EN 795.

Install the end attachments (D) and (E) at the anchorage points provided. For installation onto anchorage points (e.g. EAP-STABIL-10), use the indicated drilling "▲" (Ø 17 mm).

For a separation of more than 15 m between the anchorage points, equip the cable system with intermediate brackets (J) and/or corner elements (K). Install the intermediate brackets and the corner elements at the anchorage points provided.

# 12

## INSTALLATION SUBSTRUCTURE



INNOTECH "LIFELINE-KIT" can be installed on façades, flat roofs, and sloping roofs.

The basic requirement for professional/proper installation is a statically load-bearing **installation substructure** and the use of the original fasteners listed in the relevant instruction manual.



### **DANGER TO LIFE as a result of installation on an unsuitable installation substructure.**

- Install INNOTECH "LIFELINE-KIT" anchorage points in a statically load-bearing installation substructure (e.g. solid concrete with a minimum concrete quality of C20/25).
- **DO NOT install on screed, levelling concrete, blinding concrete etc....**
- In cases of doubt, have the installation substructure examined by a structural engineer or by the manufacturer.

# 13

## INSTALLATION TOOL

[mm]

2x

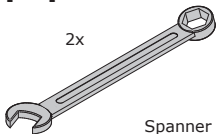

Spanner size = 19

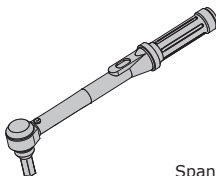
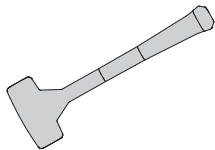

Spanner size = 5

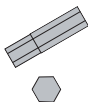

# 14 INSTALLATION

- 1.** Bolt the end lock (C) and the end attachment (E) together using the kit (F).

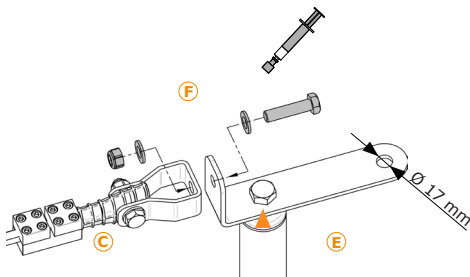

For installation onto anchorage points, use the indicated drilling "▲".

- 2.** The stud bolt should project approximately 4 thread turns beyond the lock nut.

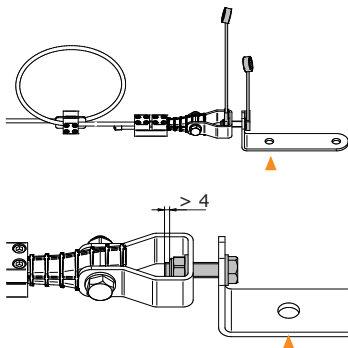

**OPTIONAL:****Corner element (K)**

Guide the stainless steel cable through the clamp (a) of the shock absorber and the  $\varnothing$  12 mm drilling of the corner element (b).

Pull the stainless steel cable taut, and tighten the bolts of clamp (a) "cross-wise" to **4 Nm**.

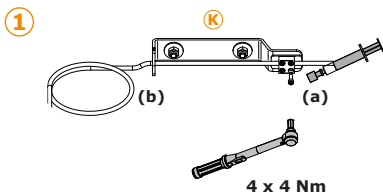
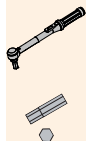

Comply with the prescribed torque.

Guide the stainless steel cable through the  $\varnothing$  12 mm drilling of the second corner element (c) and the second clamp (d) of the shock absorber.

In the corner area of the cable run, create a cable loop with a diameter of 220 mm.

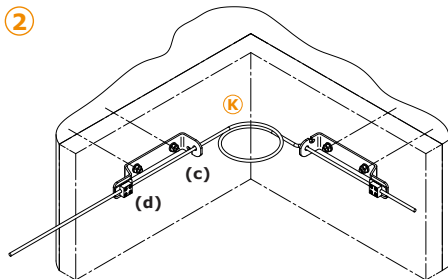

Fix the stainless steel cable in clamp (d) by tightening the bolts to **4 Nm**.

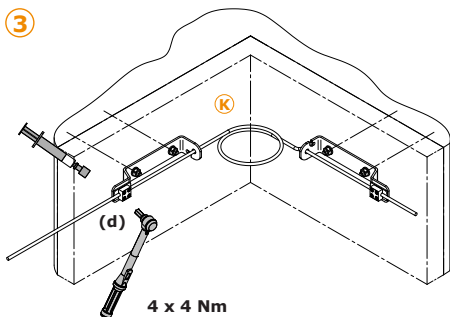

Comply with the prescribed torque.

**OPTIONAL:**

**Intermediate bracket (J)**

Guide the stainless steel cable through the intermediate bracket (J).

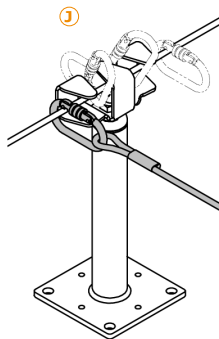

Pass-over capability without removing or repositioning the carabiner.



3.

Lead the loose cable end to the end attachment, and pre-tension to a maximum force of 50 to 80 kg.

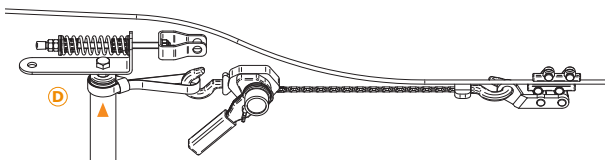

Comply with the maximum force.

4.

Thread the indicator clamp (H) and the thimble retractor (G.2) onto the stainless steel cable.

At a distance of 120 mm from the end attachment, bend the stainless steel cable.

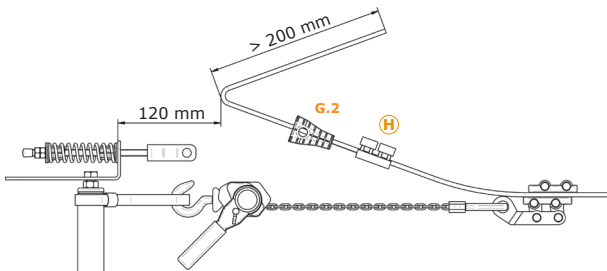

# 14 INSTALLATION

5. Guide the loose cable end back through the thimble retractor (G.2).

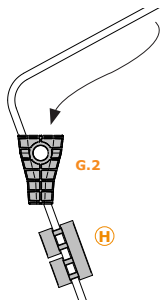

6. Position the thimble (G.3) in the thimble retractor (G.2).

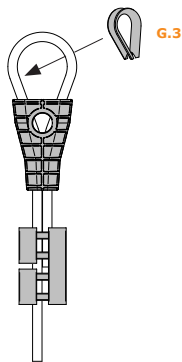

# 14 INSTALLATION

- 7.** Pull taut the cable loop and thimble (G.3) into the thimble retractor (G.2).

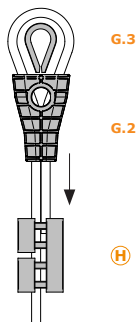

- 8.** Use a few hammer taps (plastic mallet) on the pre-tensioned cable thimble within the cable loop to push the cable thimble into the thimble retractor.

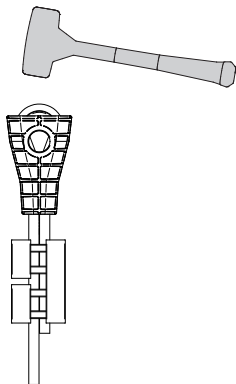

# 14 INSTALLATION

9.

Attach the end lock clamp (H) directly to the thimble retractor (G). Tighten the bolts in the end lock clamp to **10 Nm**. Push on the closing cap (G.1).

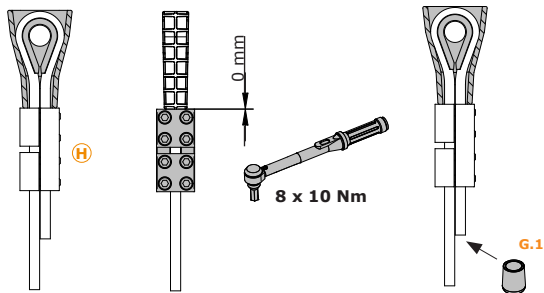
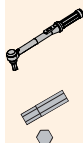

Comply with the prescribed torque.

10.

Guide the end lock (C) into the retaining bracket of the end attachment (D), and bolt it using the kit (I).

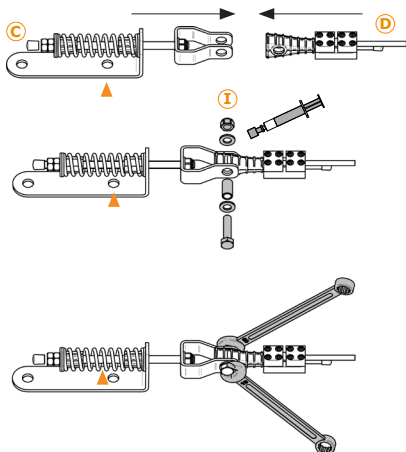

11.

Release the chain tightener.

Adjust the cable tension at the end attachment using the tension nut and counter nut.

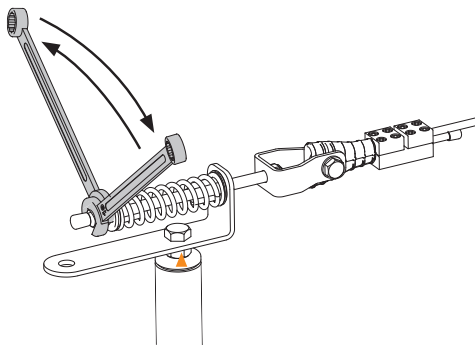

Spring length (after tensioning) between 80 – 125 mm.

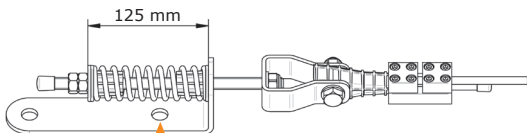

By checking the spring length, the effect of a previous fall can be observed even before using the INNOTECH "LIFELINE-KIT" fall protection system.

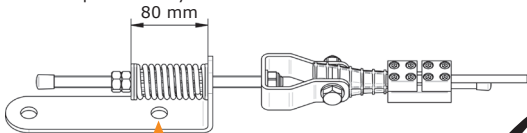

**DONE!**



# 14

## INSTALLATION



### **DANGER TO LIFE from incorrect use.**

- Connect to the stainless steel cable run, using a carabiner compliant to EN 362.
- NEVER connect to the cable loop (see diagram).

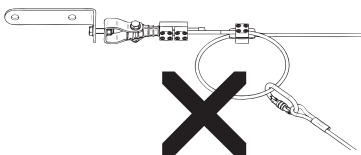

# 15

## FALL HEIGHT

**The lanyard must be kept as short as possible.**

### **Beware of the fall height.**

Adjust the personal safety equipment appropriately for reduced fall heights (canopies, balconies, etc.). For this, use fall protection systems in accordance with the applicable standards or workers' protection regulations.

### **Fall protection system in accordance with EN 358:**

Through the correct use of the appropriate lanyards or fall arresters, a fall protection system prevents a free fall. Keep the connection to the anchorage system as short as possible.

### **Designation:**

If partial runs have been designated as a fall protection system, they must be identified with additional markings. The additional markings are attached directly and permanently to the start and end of the partial run.



Beware of the fall height.

# 15

## FALL HEIGHT

The minimum free space necessary between the edge and the ground is calculated as follows:

Manufacturer's specification for the personal protective equipment used + max. deflection of the cable (2.5 m) + body height + at least 1m safety margin.

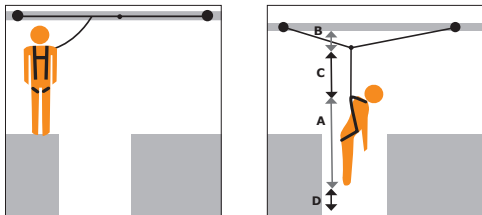

- A** User approx. 1.8 m
- B** Change in length of the cable system after loading (max. cable deflection for LIFELINE-KIT 2.5 m)
- C** the fall height specified by the manufacturer of the fall protection system as per EN 363 (depending on the type of system used, this can range from 0.5 m to 4.0 m)
- D** Safety margin of approx. 1 m  
= necessary free space below the possible fall point

# 16

## WASTE DISPOSAL

Do NOT dispose the fall protection system in the house waste. As per national requirements, gather together the used parts, and dispose of them for environmentally correct recycling.

## ACCEPTANCE LOG NO. \_\_\_\_\_ (PART 1/2)

L I F E L I N E - K I T

ORDER NUMBER:

**PROJECT:****CLIENT:** \_\_\_\_\_ Specialist: \_\_\_\_\_

Company address: \_\_\_\_\_

**CONTRACTOR:**

\_\_\_\_\_ Specialist: \_\_\_\_\_



Company address: \_\_\_\_\_

**INSTALLATION: HORIZONTAL LIFELINE SYSTEM** as per EN 795:2012 TYPE C**DESIGNATION:** Cable system no.: \_\_\_\_\_

Company address: \_\_\_\_\_ Specialist: \_\_\_\_\_

**INSTALLATION: ANCHORAGE POINTS** of the horizontal lifeline system

Company address: \_\_\_\_\_ Specialist: \_\_\_\_\_



## FASTENER &amp; PHOTO DOCUMENTATION

**PRODUCT:**  Item \_\_\_\_\_ Year of construction/Serial number: \_\_\_\_\_

(Type designation: anchorage point e.g. EAP-STABIL-10-300)

Installation substructure: \_\_\_\_\_

(e.g. solid concrete, concrete products: C20/25, wood rafter dimension, for sheet metal roofs: roof manufacturer, profile, material, sheet metal thickness, etc.)

Date:	Location:	Dowel type: BEF/Sticker?/Designation	Setting depth: [mm]	Drill bit Ø: [mm]	Tightening torque:	Photos: (storage location)
			mm	mm	Nm	

**DIFFERENT ATTACHMENTS/ANCHORAGE POINTS (TYPES,  
INSTALLATION SUBSTRUCTURES; SERIAL NUMBERS, ETC.) MUST BE SPECIFICALLY LISTED.****PRODUCT:**  Item \_\_\_\_\_ Year of construction/Serial number: \_\_\_\_\_

(Type designation: anchorage point e.g. EAP-STABIL-10-300)

**INSTALLATION SUBSTRUCTURE:** \_\_\_\_\_

(e.g. Mass concrete, concrete products: C20/25, wood rafter dimension, for sheet metal roofs: roof manufacturer, profile, material, sheet metal thickness, etc.)

Date:	Location:	Dowel type: BEF/Sticker?/Designation	Setting depth: [mm]	Drill bit Ø: [mm]	Tightening torque:	Photos: (storage location)
			mm	mm	Nm	



## ACCEPTANCE LOG NO. \_\_\_\_\_ (PART 2/2)

L I F E L I N E - K I T

**DIFFERENT ATTACHMENTS/ANCHORAGE POINTS (TYPES, INSTALLATION SUBSTRUCTURES, SERIAL NUMBERS, ETC.) MUST BE SPECIFICALLY LISTED.****PRODUCT:**  Item \_\_\_\_\_ Year of construction/Serial number: \_\_\_\_\_

(Type designation: anchorage point e.g. EAP-STABIL-10-300)

Installation substructure: \_\_\_\_\_

(e.g. Mass concrete, concrete products: C20/25)

Date:	Location:	Dowel type: BEF/Sticker?/Designation	Setting depth: [mm]	Drill bit Ø: [mm]	Tightening torque:	Photos: (storage location)
			mm	mm	Nm	

The installation company who signs warrants proper workmanship (edge spacing, inspection of the substructure, proper cleaning of bores, compliance with curing times and processing temperature, compliance with the dowel manufacturer's guidelines, etc.)

The client accepts the performances of the contractor. The instruction manual, documentation of the fastenings, and photo documentation and test sheets have been transferred to the client (building owner) and have been made available to the user. At the access to the safety system, the building owner must document the positions of the anchorage devices by means of diagrams (e.g. view of the roof from above).

**The expert fitter familiar with the safety system confirms that the installation work has been executed properly, in accordance with the state of the art, and in accordance with the manufacturer's operating instructions. The technical safety reliability is confirmed by the installation company.**

**Transfer of:** (e.g. personal protective equipment PPE, self retracting lanyards SRL, storage cabinet, etc.) Item \_\_\_\_\_  Item \_\_\_\_\_  Item \_\_\_\_\_  Item \_\_\_\_\_Included in lightning protection system?  YES  NO**Comments:** \_\_\_\_\_Name: \_\_\_\_\_  
Client

Fitter - EAP/anchorage points

\_\_\_\_\_  
Date, company stamp, signature\_\_\_\_\_  
Date, company stamp, signature\_\_\_\_\_  
Fitter - horizontal lifeline system\_\_\_\_\_  
Date, company stamp, signature

**INSTRUCTIONS FOR THE EXISTING  
SAFETY SYSTEM**

**The building owner must affix this notice in a conspicuous location near the access to the system!**

This system must be used in accordance with the state of the art and the instruction manual.

The storage location for the instruction manual, test logs, etc. is:

- Overview diagram showing the position of the anchorage devices:

**Mark non shatter-proof areas (e.g. skylights and/or light strips)!**

The maximum limit values of the safety system are provided in the relevant instruction manuals or the rating plate of your system.

If there is strain caused by fall, or if in doubt, the anchorage device must be taken out of service immediately and sent to the manufacturer, or to a specialised workshop for inspection and repair.

The same applies if there is damage to the anchorage equipment.

## TEST LOG NO. \_\_\_\_\_ (PART 1/2)

L I F E L I N E - K I T

ORDER NUMBER: \_\_\_\_\_

PROJECT: \_\_\_\_\_

PRODUCT: Horizontal lifeline system LIFELINE-KIT Designation: CABLE SYSTEM no.: 

ANNUAL SYSTEM CHECK PERFORMED ON: \_\_\_\_\_

ANNUAL SYSTEM CHECK AT THE LATEST BY: \_\_\_\_\_

CLIENT: Specialist: 

Company address: \_\_\_\_\_



CONTRACTOR: Specialist: 

Company address: \_\_\_\_\_

INSPECTION POINTS: <input checked="" type="checkbox"/> checked and in order!	DEFECTS DETECTED: (Description of defects/measures)
<b>DOCUMENTATION:</b>	
<input type="checkbox"/> Instruction manual	
<input type="checkbox"/> Inspection logs/Fastener documentation/Photo documentation	
<b>PPE (personal protective equipment) against falls from a height:</b> Inspection in accordance with manufacturer's specifications	
<input type="checkbox"/> Expiration date	
<input type="checkbox"/> annual inspection performed	
<input type="checkbox"/> not checked (no authorisation)	
<b>ROOF SEALING:</b>	
<input type="checkbox"/> no damage	
<input type="checkbox"/> no corrosion	
<b>VISIBLE PARTS OF THE ANCHORAGE DEVICE:</b>	
<input type="checkbox"/> no deformation	
<input type="checkbox"/> no corrosion	
<input type="checkbox"/> Screw connections secured	
<input type="checkbox"/> Tightening torque of the fastening bolts	
<input type="checkbox"/> firmly seated	

## TEST LOG NO. \_\_\_\_\_ (PART 2/2)

L I F E L I N E - K I T

INSPECTION POINTS: <input checked="" type="checkbox"/> checked and in order!	DEFECTS DETECTED: (Description of defects/measures)
<b>STAINLESS STEEL CABLE:</b>	
<input type="checkbox"/> Visual inspection	
<input type="checkbox"/> Cable strands	
<input type="checkbox"/> ...	
<b>INTERMEDIATE CABLE BRACKETS:</b>	
<input type="checkbox"/> no deformation	
<input type="checkbox"/> no corrosion	
<input type="checkbox"/> Screw connections secured	
<b>CORNER FASTENINGS:</b>	
<input type="checkbox"/> no corrosion	
<input type="checkbox"/> no deformation	
<input type="checkbox"/> Screw connections secured	
<input type="checkbox"/> Cable loops Ø approx. 220 mm	
<input type="checkbox"/> Screw torque for shock absorber (4 x 4 Nm)	
<input type="checkbox"/> ...	
<b>END ATTACHMENT AND LOCKS</b>	
<input type="checkbox"/> no corrosion	
<input type="checkbox"/> no deformation	
<input type="checkbox"/> Screw connections secured	
<input type="checkbox"/> Damage to plastic components	
<input type="checkbox"/> Screw torque for shock absorber (4 x 4 Nm)	
<input type="checkbox"/> Cable loops Ø approx. 220 mm	
<input type="checkbox"/> Screw torque of bolts for end lock clamp (8 x 10 Nm)	
<input type="checkbox"/> Cable pre-tension: Spring tension range 50 to 125 mm.	

**Acceptance result:** The safety system corresponds to the specifications in the manufacturer's instruction manual and to the state of the art. Technical safety reliability is confirmed.

**Comments:** \_\_\_\_\_

Name: \_\_\_\_\_

Client

Validation: Contractor

(expert who is familiar with the safety system)

\_\_\_\_\_  
Date, company stamp, signature

\_\_\_\_\_  
Date, company stamp, signature

INNOTECH® Arbeitsschutz GmbH, Laizing 10, 4656 Kirchham/Austria  
[www.innotech.at](http://www.innotech.at)



