









## Skylight protection system **LIGHT**



The stable **LIGHT** collective fall prevention system from **INNOTECH®** can be implemented in any desired dimensions and is the robust solution for very varied types of skylights and strip lights. Installation is quick and straightforward and is possible on wood, concrete, steel and plastic.

-  fall-through protection for open and enclosed skylights
-  high-quality look for office and retail spaces (RAL to choice)
-  high permeability to light and smoke
-  simple to install or retrofit
-  individual solutions possible for various types of skylights
-  variable section sizes for opening mechanism
-  successful dynamic testing using 100 kg from a fall height of 1.2 m!
-  certification to the latest state of the art:

GS-BAU-18 version February 2001  
EN 1873:1263  
EN 14963:2006

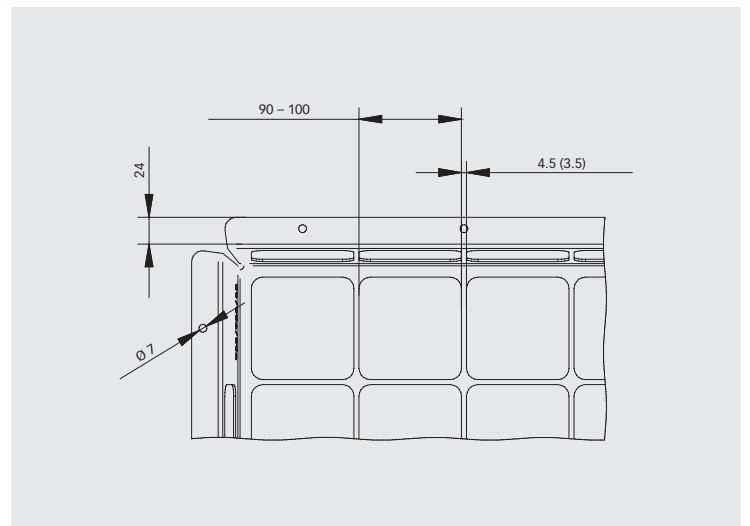

### **LIGHT** **SKYLIGHT PROTECTION SYSTEM (EN 1263-1)**

Mesh width: max. 100 x 100 mm  
Material: galvanised steel

High light and smoke permeability - straightforward installation and easy retrofitting.

Various RAL colours, other mesh widths and special shapes (e.g. round) available on request!